

ENTDECKEN SIE DIE NEUEN KONOLD TÜREN



KONOLD Härtsfelder Holzindustrie GmbH
Oberer Weiler 19
89561 Dischingen-Katzenstein
Tel. 07326 / 9600 - 0
Fax: 07326 / 9600 - 335
info@konold.com



KONOLD Türen ist ein mittelständisches Unternehmen, das nun bereits in 3. Generation mit 150 Mitarbeitern hochwertige Innentüren für Ihr Zuhause fertigt.

Idyllisch gelegen in Katzenstein, auf der schwäbischen Alb hat sich ein hochmodernes Türenwerk mit angeschlossener Schreinerei entwickelt. Dort vereinen wir tagtäglich die Vorteile industrieller Fertigung und unserer individuellen Handwerksleistung.

Warum Konold	4
Neuheiten	6
Glatte Türen	14
Motivfräsungen	22
Lisenen	24
Intarsientüren	26
Lichtausschnitte	30
Konglastüren	34
Ganzglas (Rille).....	38
Stiltüren mit aufgesetzten Leisten	40
Echte Füllungstüren	42
Landhaustüren	46
HPL.....	50
Schiebetüren	52
Furnierauswahl	54
Zubehör.....	56
Bekleidungsformen / Furnierart / Furnierrichtung	58

JEDES MASS AB STÜCKZAHL 1

Wir fertigen Türen in jeder auf dem Markt verfügbaren Holzart ab Stückzahl 1

TÜRENMASSE:

- Breite bis 2250 mm (am Stück)
- Höhen bis 3500 mm (am Stück)

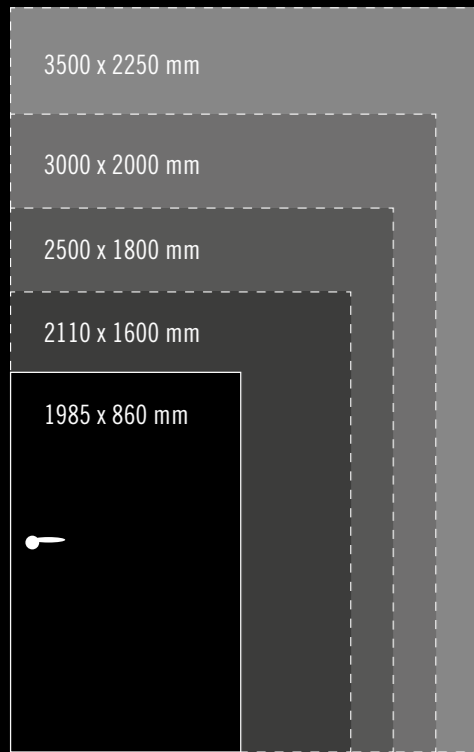

ZARGENMASSE:

- Breite bis 3500 mm (am Stück)
- Höhen bis 3500 mm (am Stück)

BEKLEIDUNGSBREITEN

- Kantig von 50-140 mm im 5 mm Rhythmus
- Soft, Soft2, Befa und Beka von 60-140 mm im 5 mm Rhythmus
- Bebo in 80 mm

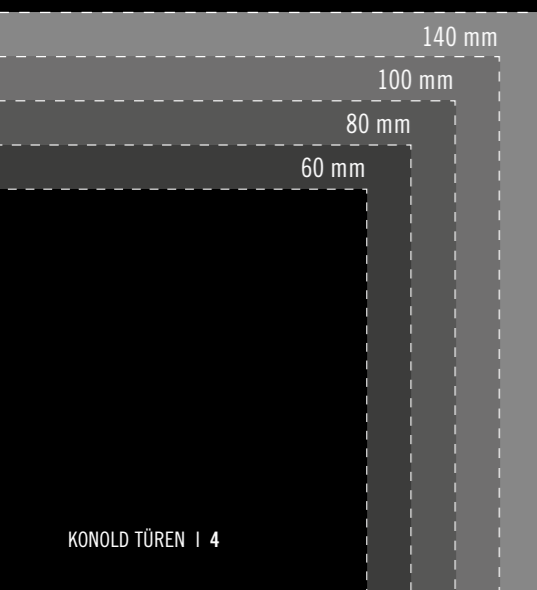

90 VERSCHIEDENE FURNIERE AUF LAGER



MAGNETSCHLOSS

Standard bei stumpfen Türen und optional bei gefälzten Türen

KONOLD EXPRESS PROGRAMM

- 4-6 Fertigungstage
- 16 verschiedene Oberflächen
- Höhen bis 2110 mm
- Breiten bis 1235 mm
- Wandstärke bis 480 mm

Nähere Infos dazu in unseren gesonderten Broschüren



RAL HANDLACKIERTE ZARGEN

werden generell vormontiert geliefert

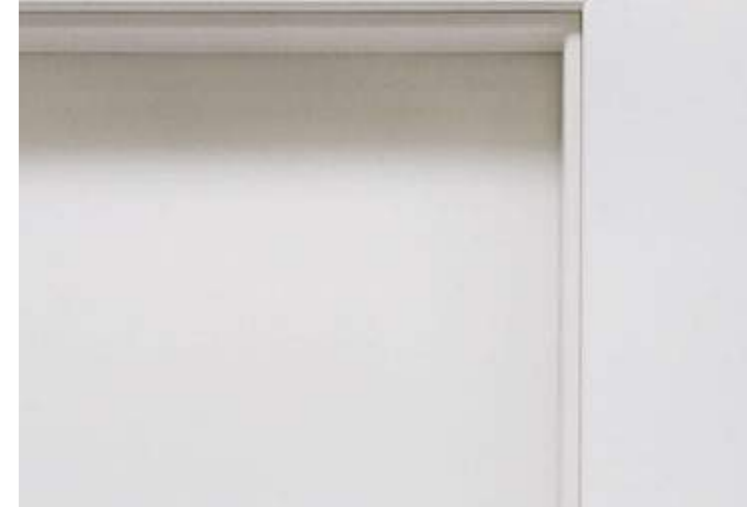

MASSIVE METALLANKERPLATTE

Für mehr Sicherheit, standard in jeder Zarge



MASSIVES RAHMENHOLZ

Massiver Fichte Tanne Rahmen jede Tür 5 cm kürzbar



TÜREN NEUHEITEN EICHE

LANDEICHE
PARKEICHE
EICHE ASTIG



Oberfläche: Landeiche
Modell: Naomi 01
Zarge: Eiche Astig Soft



Oberfläche: Parkeiche
Modell: Naomi 01
Zarge: Eiche Astig Soft



Oberfläche: Eiche Astig
Modell: Naomi 01
Zarge: Eiche Soft



TÜREN NEUHEITEN EICHE

STARKFURNIER
STREIFENEICHE
GRAUEICHE

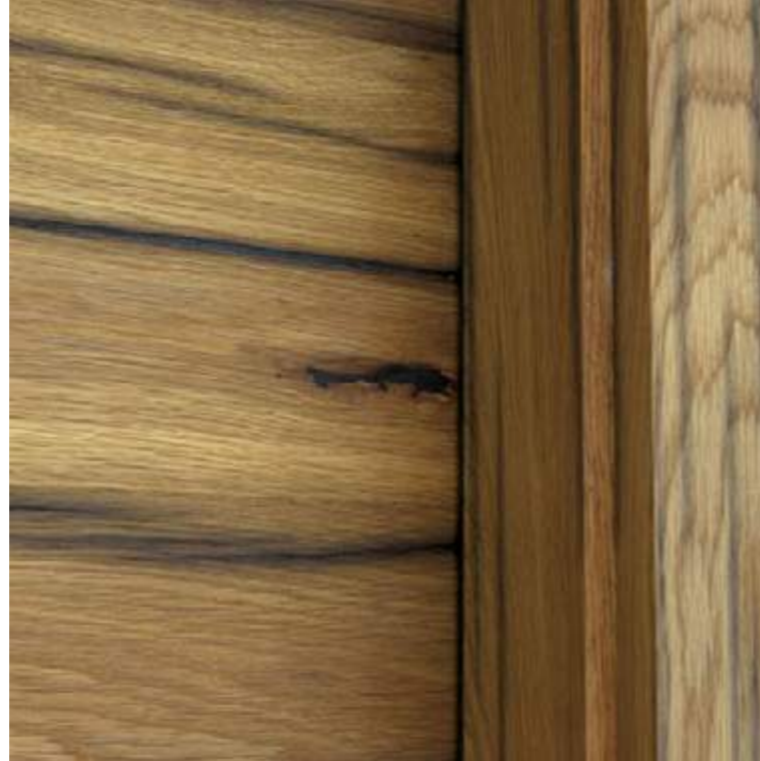

Oberfläche: Streifeneiche
Modell: Naomi 01
Zarge: Eckig



Oberfläche: Graueiche
Modell: Naomi 01
Zarge: Eckig



TÜREN NEUHEITEN ALTHOLZ

STARKFURNIER

EICHE

FICHTE

BALKENEICHE



Oberfläche: Altholz Eiche
Modell: G00
Zarge: Eckig Stumpf



Oberfläche: Altholz Fichte
Modell: Naomi 01
Zarge: Eckig



Oberfläche: Balkeneiche
Modell: G00
Zarge: Eckig

TÜREN NEUHEITEN NEW YORK

FRIESTÜRE MIT AUSWECHSELBARER EINLAGE

- Einlagenbreite 10 oder 20 cm breit
- Einlagenposition mittig, band- oder schlossseitig
- Einlage längs- oder querfurniert erhältlich
- Oberfläche der Einlage nach Kundenwunsch wählbar



Modell: New York 10 S
Einlage: Callisto längs
Oberfläche: RAL Weiß
Zarge: Soft



Modell: New York 10 S
Einlage: Titan quer
Oberfläche: RAL Weiß
Zarge: Soft



Modell: New York 10 S
Einlage: Fichte Altholz längs
Oberfläche: RAL Weiß
Zarge: Soft

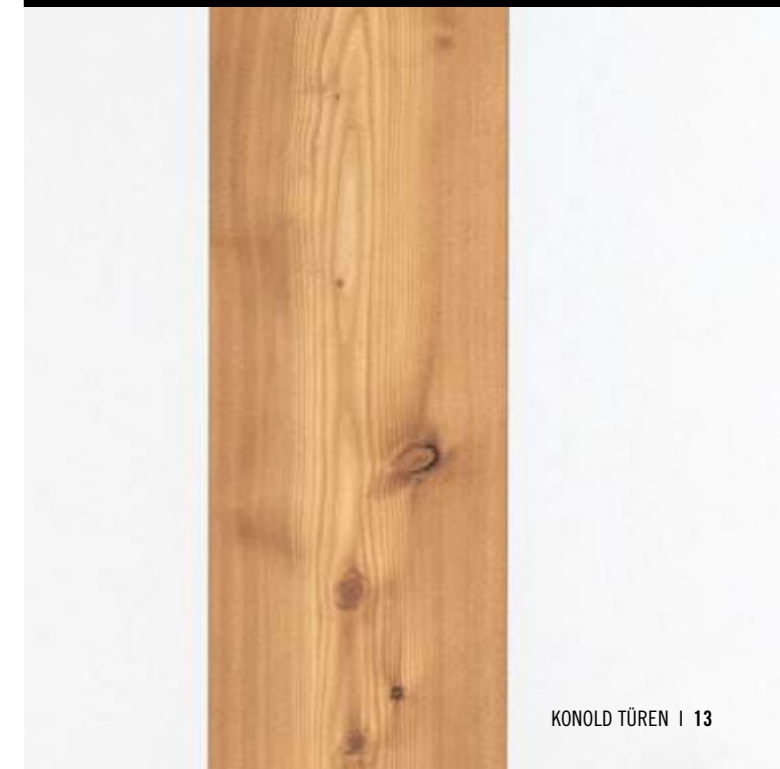

KONOLD TÜREN

GLATTE TÜREN G00

- Kantenformen: Soft, Kantig, Soft2 und Karnies möglich
- Mittellage: Spezialverbundplatte, Röhrenspankern, Vollspankern oder Stäbchenmittellage möglich
- massiver Fichte / Tanne Rahmen (5 cm kürzbar)



Oberfläche: Kernesche
Modell: G00
Zarge: Soft



Oberfläche: Amerikanischer Nussbaum
Modell: G00
Zarge: Eckig UNO



Oberfläche: Buche
Modell: G00
Zarge: Bebo





Oberfläche: Eiche blumig
Modell: Naomi 01
Zarge: Soft



Oberfläche: Eiche wild strukturiert
Modell: Naomi 01
Zarge: Eckig TRE 80 mm



Oberfläche: Eiche KP 43
Modell: G00
Zarge: Soft



Oberfläche: Eiche schlicht
Modell: Naomi 01
Zarge: Soft



Oberfläche: Eiche Astig weiss mattlack
Modell: G00
Zarge: Eckig



Oberfläche: Canadisch Ahorn
Modell: G00
Zarge: Soft

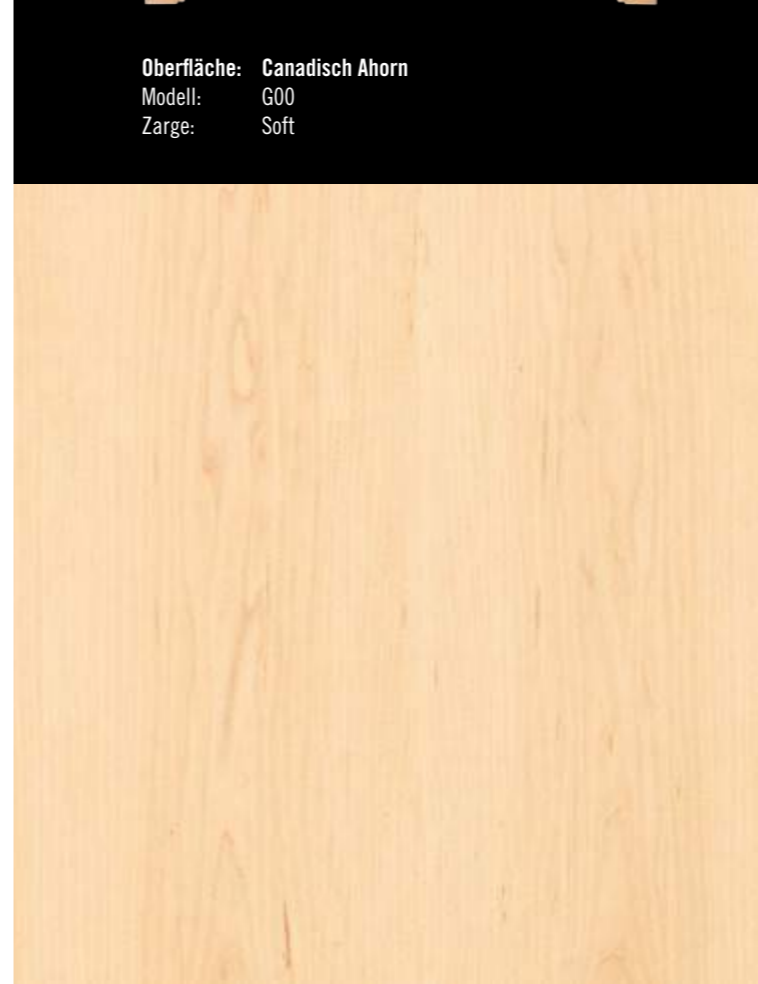

Oberfläche: Fichte
Modell: G00
Zarge: Soft



Oberfläche: Kernbuche Baumstammoptik
Modell: G00
Zarge: Bebo Buche



Oberfläche: Kernbuche lebhaft
Modell: G00
Zarge: Bebo Buche



Oberfläche: Vogelaugenahorn
Modell: G00
Zarge: Soft Canadisch Ahorn



Oberfläche: Riegelahorn
Modell: G00
Zarge: Soft Canadisch Ahorn

KONOLD TÜREN MOTIVFRÄSUNGEN

- Fräsrille in MDF Naturbelassen
- Fräsrille in RAL-Oberfläche lackiert
- Fräsrille Echtholz



SMALL

Fräsrille 8 mm
Echtholz



MEDIUM

Fräsrille 12 mm
Echtholz



LARGE

Fräsrille 22 mm
Echtholz



SQUARE

Fräsrille 6 mm
Echtholz



Oberfläche: Amerikanischer Nussbaum
Motivfräsung: M6 - Echtholz Canadisch Ahorn
Modell: G00
Zarge: Eckig UNO



Oberfläche: RAL Weiss
Motivfräsung: M45
Modell: G00
Zarge: Soft

MODELLVARIATIONEN

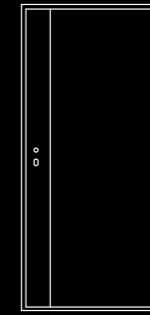

M1

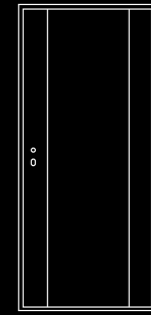

M2

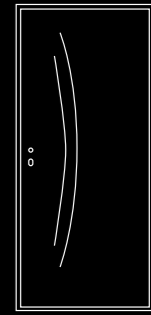

M3

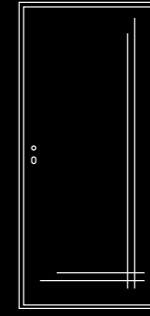

M9

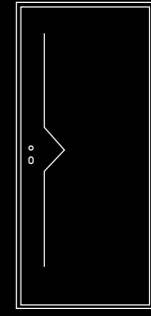

M15

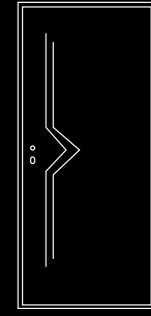

M16

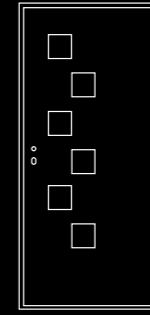

M29

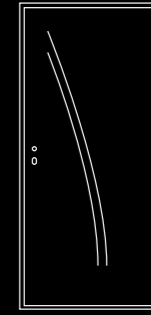

M30

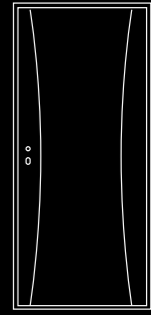

M33

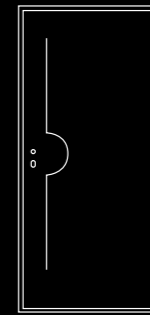

M42

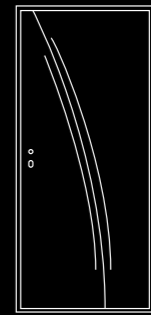

M45



M47

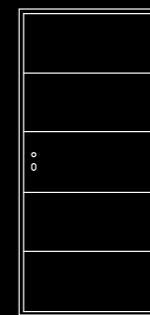

M50

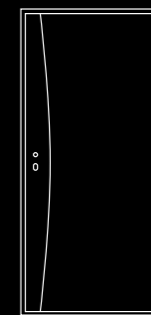

M52

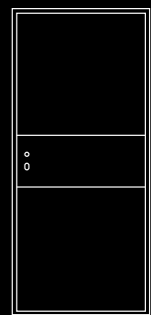

M56

KONOLD TÜREN LISENEN

- Erhältlich in Edelstahloptik, Edelstahl und in allen Holzarten
- Lisenenbreite 15mm Standard
- Abweichende Lisenenbreite auf Anfrage



Oberfläche: Französischer Nussbaum
Lisene: L3 - Edelstahl
Modell: G00
Zarge: Soft

LISENE EDELSTAHL



LISENE HOLZ



Oberfläche: Amerikanisch Nussbaum
Lisene: L53 - Canadisch Ahorn
Modell: Naomi 01
Zarge: Soft Canadisch Ahorn

MODELLVARIATIONEN

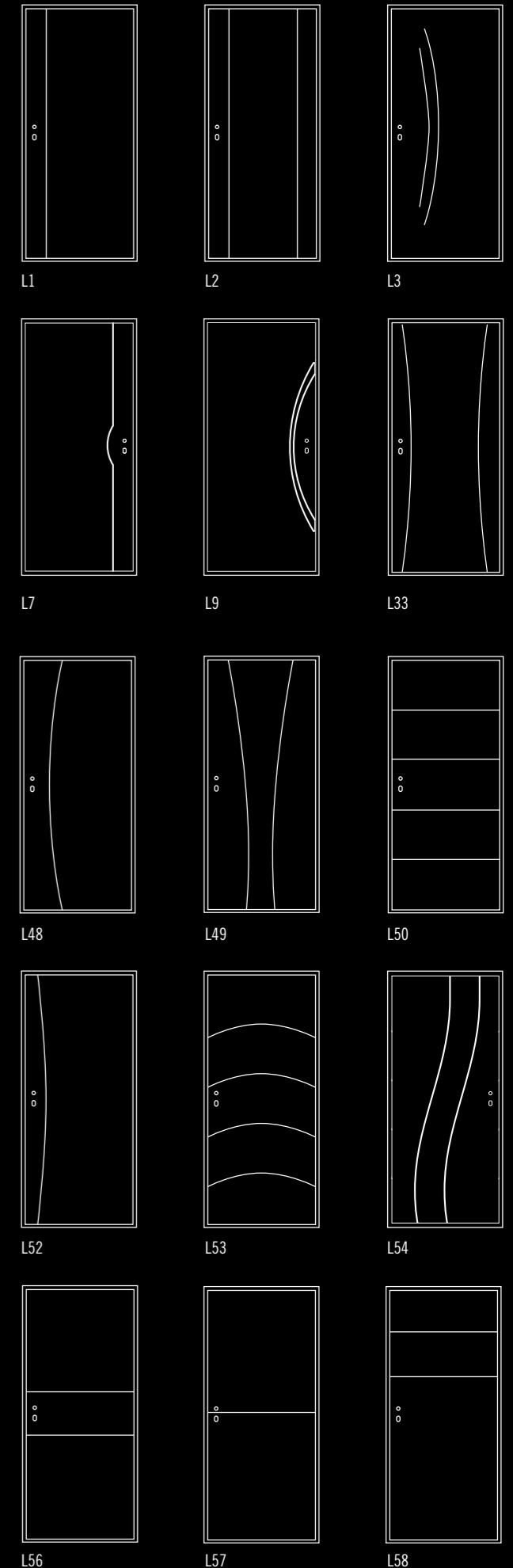

KONOLD TÜREN INTARSIENTÜREN

- Mittellage: Röhrenspankern, Vollspan oder Stäbchenmittellage
- massiver Fichte / Tanne Rahmen
- 5 cm kürzbar

Furnierrichtungen:

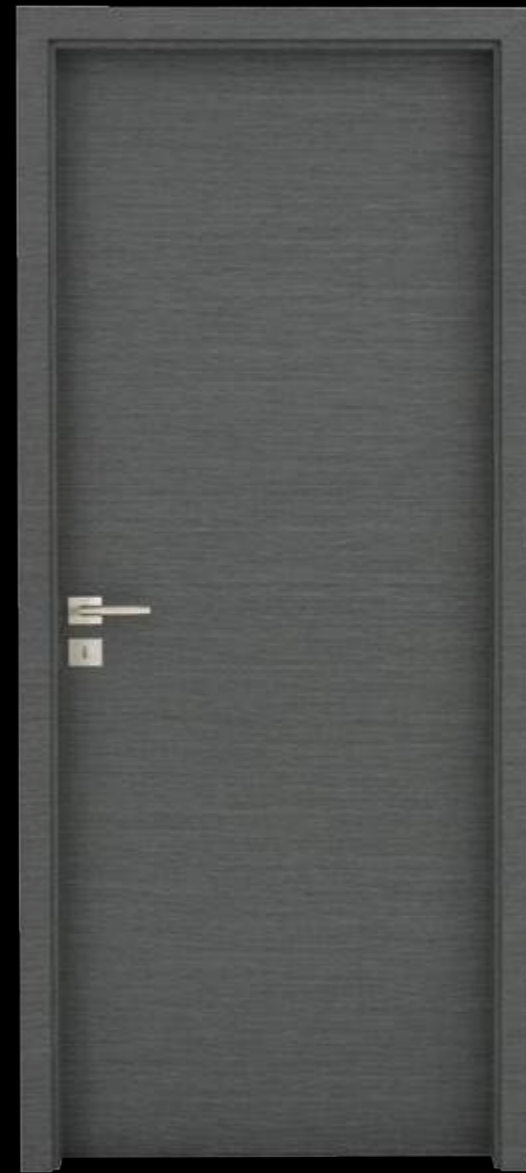
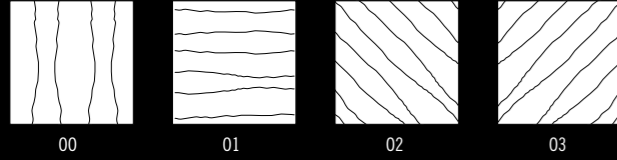

Oberfläche: Farbfurnier Titan
Modell: Naomi 01
Zarge: Eckig DUO



Oberfläche: Farbfurnier Pholus
Modell: Naomi 01
Zarge: Eckig DUO



Oberfläche: Farbfurnier Saturn
Modell: Vela 00
Zarge: Eckig UNO



MODELLVARIATIONEN

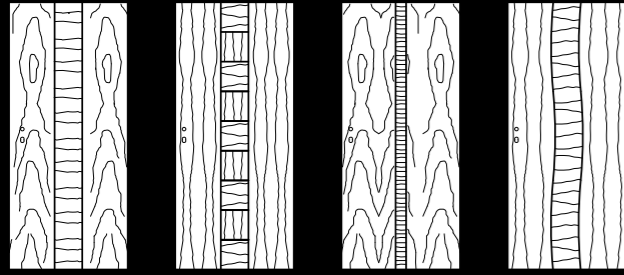

Aquila 01 Aquila 08 Ariva 08 Arosa 01

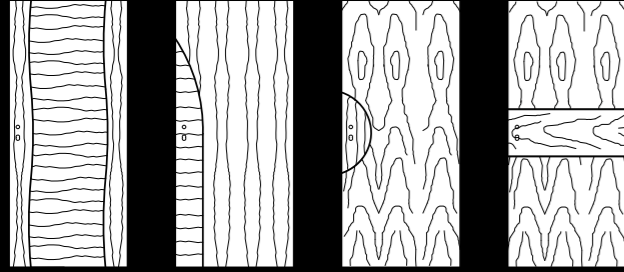

Arosa 16-01 Bigera 01 Bologna 00 Caminar 01

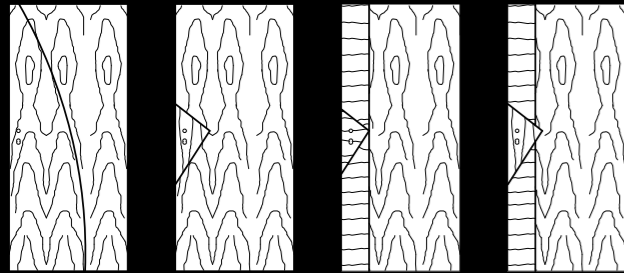

Capri 00 Imola 00 Isque 01 Laque 00

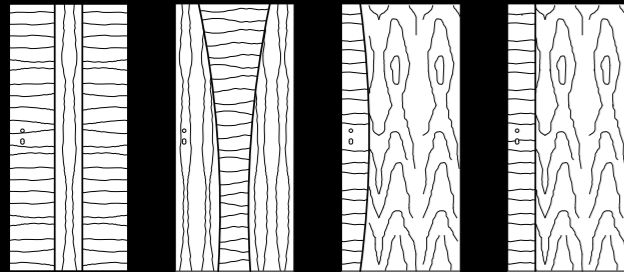

Lazia 01 Lora 01 Marenso 01 Marino 01

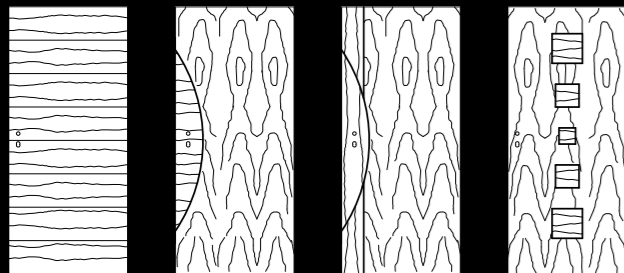

Naomi 01 Palma 01 Palmero 00 Quadra 01

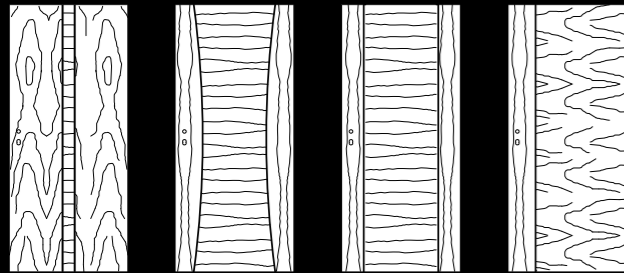

Sariva Trenso 01 Trento 16-01 Vela 00



Oberfläche: Canadisch Ahorn
Modell: Seboa 01
Zarge: Bebo



Oberfläche: Eiche blumig
Modell: Trento 1601
Zarge: Soft



Oberfläche: Eiche weiss mattlack
Modell: Vela 00
Zarge: Soft

KONOLD TÜREN LICHTAUSSCHNITTE



Oberfläche: Eiche Astig
Glas: Elba Float
Modell: Naomi 01-G04A
Zarge: Soft

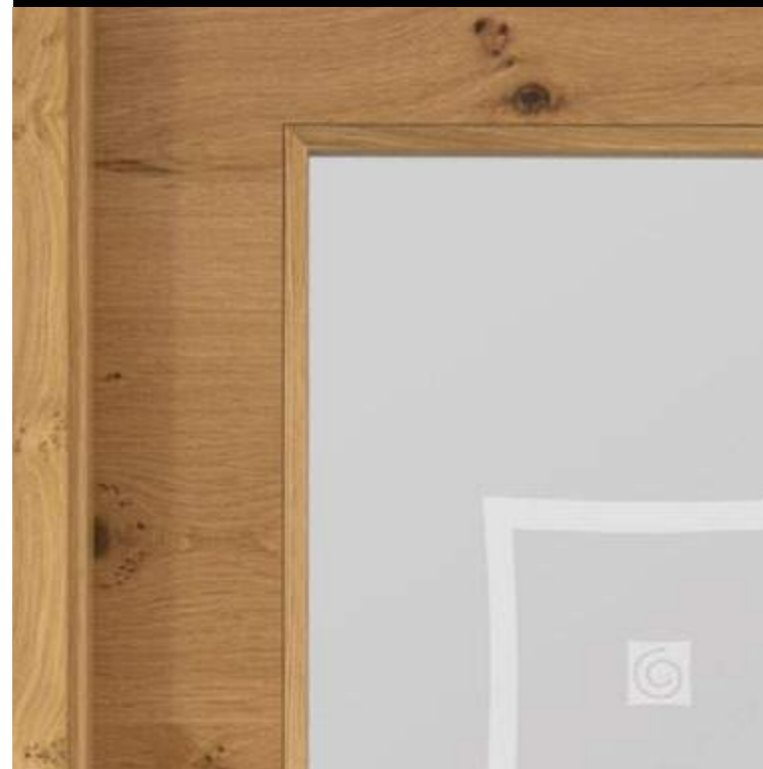

Oberfläche: Eiche blumig
Glas: Bianca Float
Modell: Naomi 01 - RE04
Zarge: Bebo

MODELLVARIATIONEN

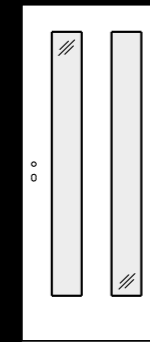

2G50

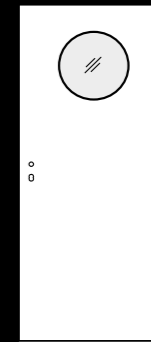

BU40

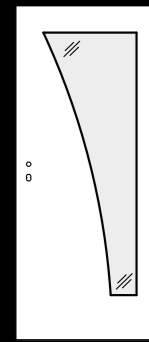

CS10

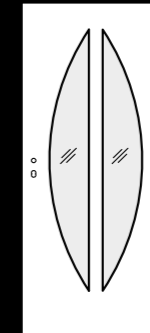

EL10

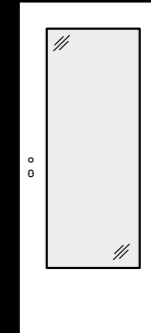

G04



G04A

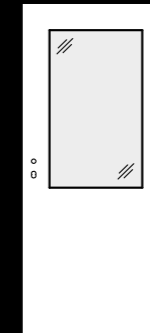

G07

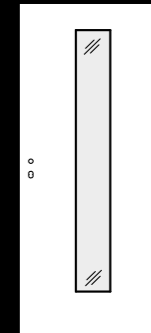

G50

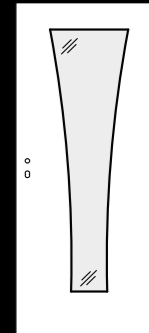

GS10

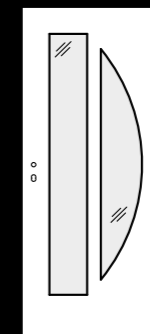

MD04

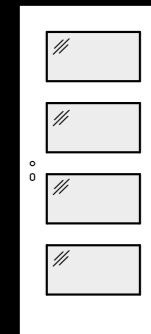

RE04

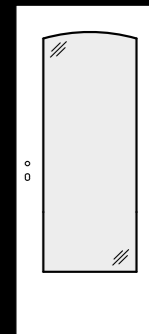

S04

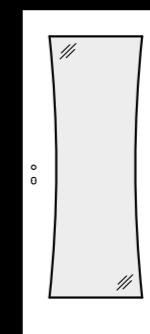

SL04

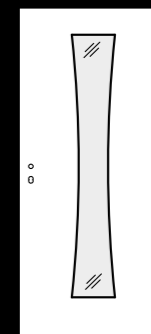

SL50

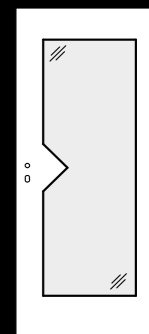

TR04

GLASLEISTENVIELFALT

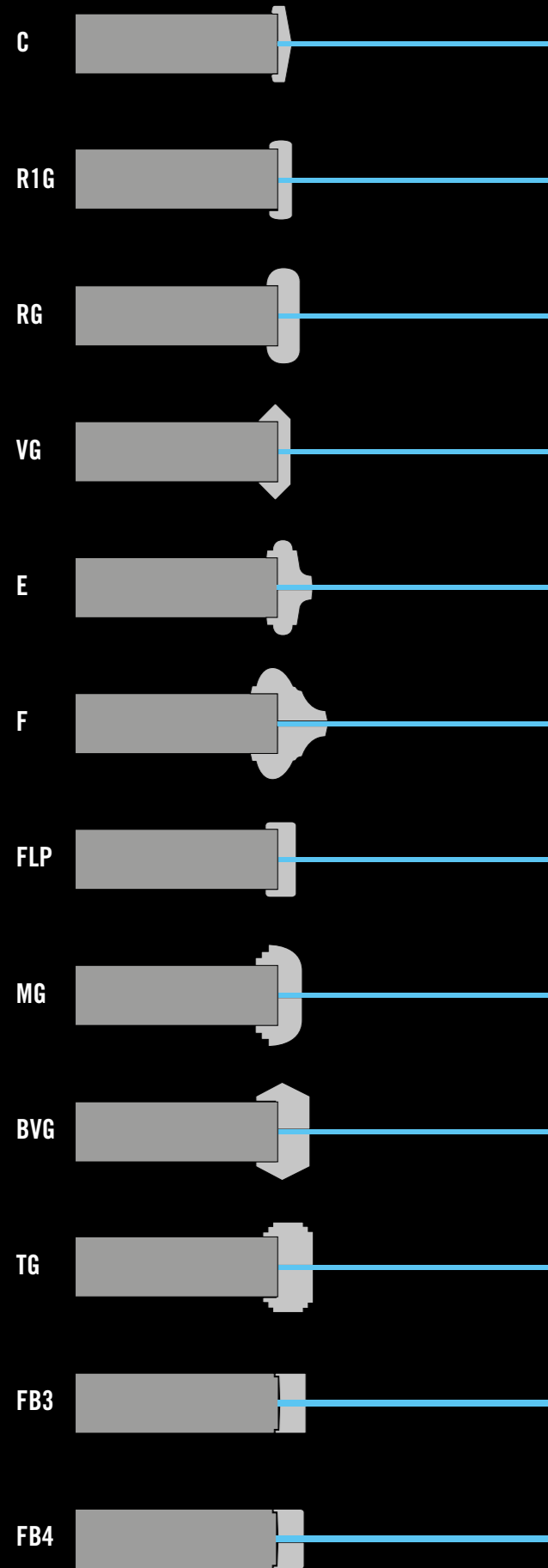

Oberfläche: Europäischer Kirschbaum
Glas: Q89 - Float Rillenschliff
Modell: G00 - SL04
Zarge: Soft



Oberfläche: Farbfurnier Titan
Glas: Laserglas 533
Modell: Naomi 01 - G04
Zarge: Eckig DUO



NEU LASERGLAS



Laser 4



Laser 13



Laser 16



Laser 17



Laser 20



Laser 638

KONOLD TÜREN KONGLASTÜREN

- Friestüre mit Glasverbund
- inklusive 8 mm Float ESG
- verschiedene Glasmodelle erhältlich



Oberfläche: Red Gum
Modell: KGL 01
Glas: Alisa negativ Float Satinato
Zarge: Bebo

KGL

Ohne zusätzliche Einfassung wird die Glasfläche ausschließlich von den Seitenfriesen gefasst.



KGL A

Mit dezentem Holzrahmen, welcher die Glasfläche zwischen den Friesen oben und unten einrahmt. Eine Kürzung bis zu 15 mm im Bodenbereich ist möglich.



Oberfläche: Canadisch Ahorn
Modell: KGL 24A
Glas: Satinato
Zarge: Bebo



Oberfläche: Canadisch Ahorn
Modell: KGL 01B
Glas: Kiara positiv Satinato
Zarge: Soft

KGL B

Mit einer Aluminiumschiene unten wird die Glasfläche am Boden geschützt. Eine Kürzung bis zu 15 mm im Bodenbereich ist möglich.





Oberfläche: Wenge
Modell: KGL 01
Glas: Q89 Satinato Rillenschliff
Zarge: Eckig



Oberfläche: RAL Weiss
Modell: KGL 36
Glas: Q63 Float Rillenschliff
Zarge: Bebo



Oberfläche: Canadisch Ahorn
Modell: KGL 01A
Glas: Serena Float Satinato
Zarge: Bebo

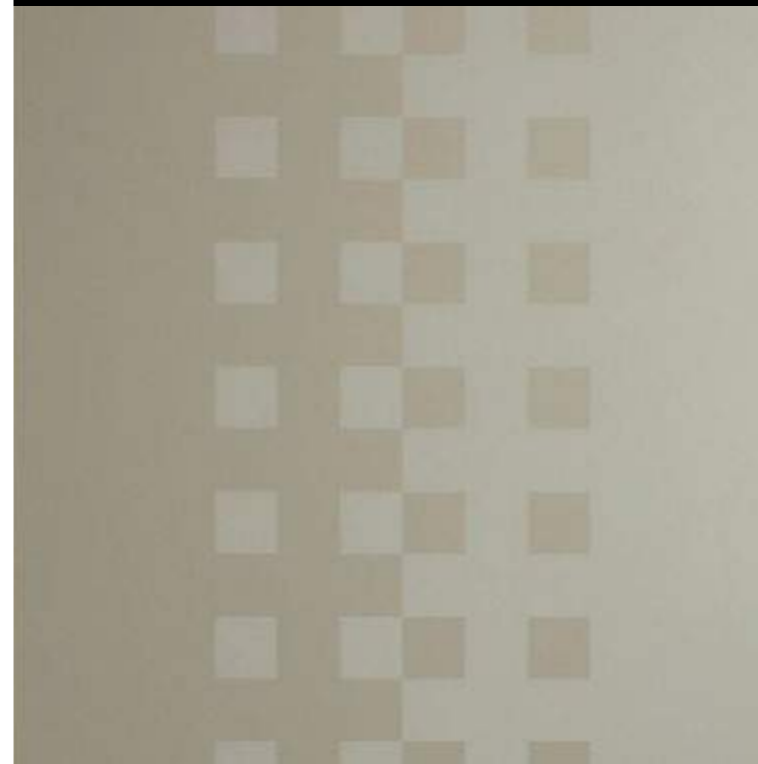

MODELLVARIATIONEN

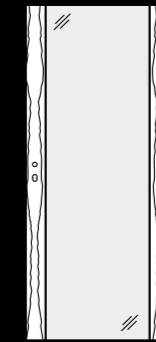

KGL 01

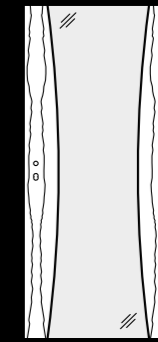

KGL 11

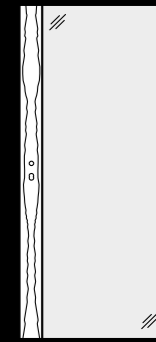

KGL 12

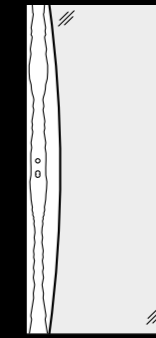

KGL 13

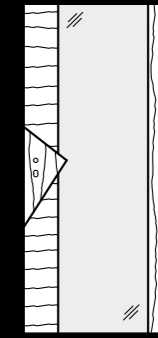

KGL 14

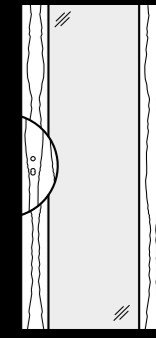

KGL 16

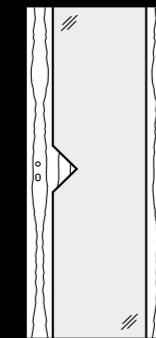

KGL 21

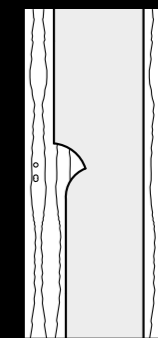

KGL 23

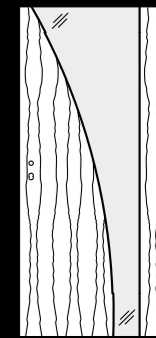

KGL 24

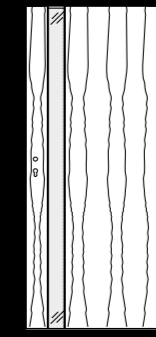

KGL 27s

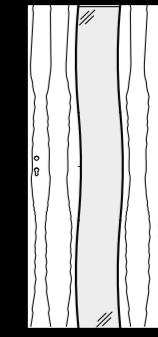

KG 30

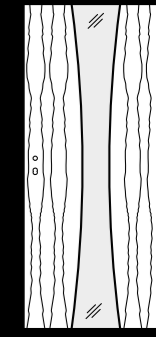

KGL 33

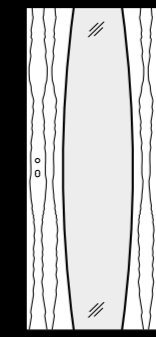

KGL 34

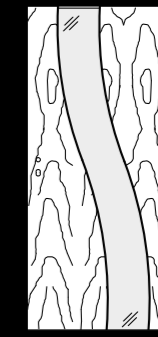

KGL 36

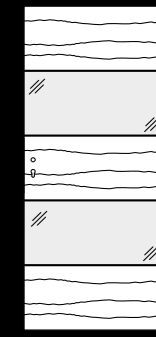

KGL 41

KONOLD TÜREN

GANZGLAS RILLENSCHLIFF

- ESG-Glas ca. 8 mm, Kanten poliert
- Bohrungen für Band- und Schloss bzw. für Muschel- / Stangengriff oder Laufbeschlag bei Schiebetüren

GRUNDGLAS FLOAT (Rille Mattiert)

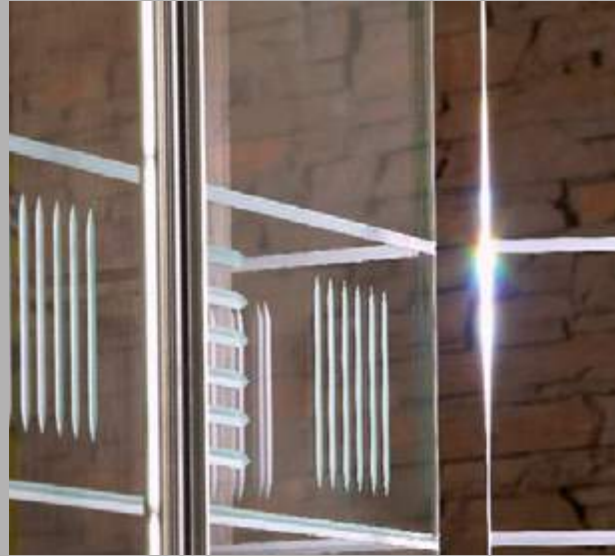

GRUNDGLAS SATINATO (Rille klar)

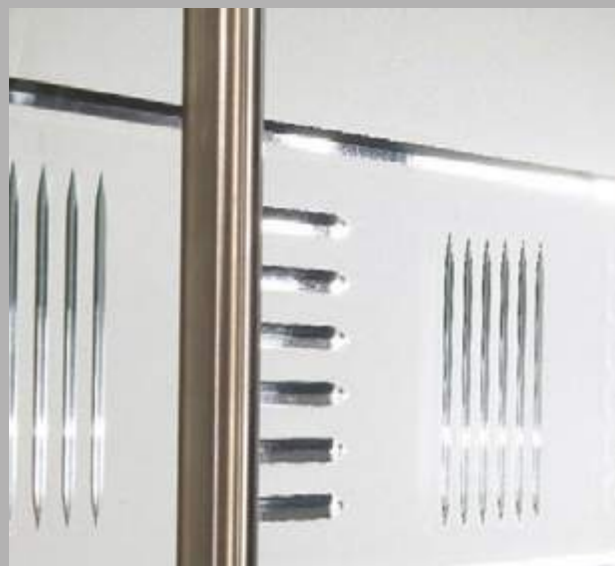

Modell: Q101
Glas: Satinato ESG Rillenschliff
Zarge: Eckig Rauchsapelli TRE 80 mm



Modell: Q50
Glas: Satinato ESG Rillenschliff
Zarge: Eckig Rauchsapelli TRE 80 mm



Modell: Q99
Glas: Float ESG Rillenschliff
Zarge: Bebo RAL Weiss



Modell: Q100
Glas: Satinato ESG Rillenschliff
Zarge: Eckig Brauneiche TRE

MODELLVARIATIONEN

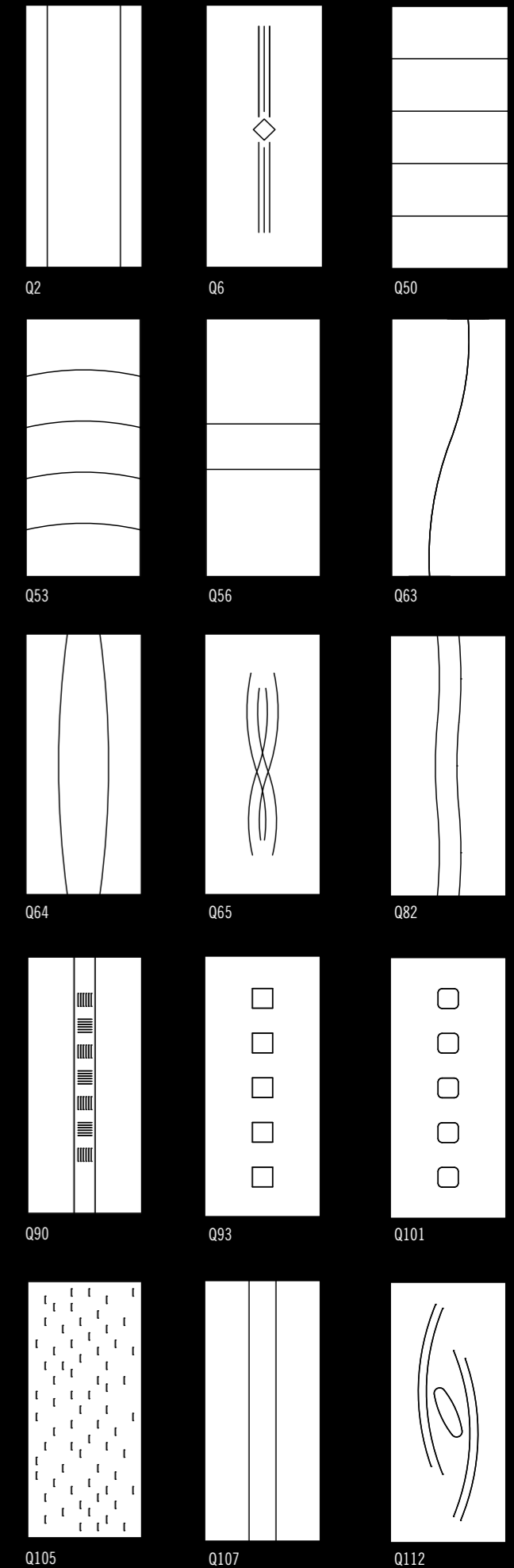

STILTÜREN MIT AUFSATZLEISTEN

- Mittellage: Röhrenspankern, Vollspankern oder Stäbchenmittellage
- massiver Fichte / Tanne Rahmen
- 5 cm kürzbar
- alternative Leistenformen auf Anfrage möglich

SAARBRÜCKEN durchlaufend furniert

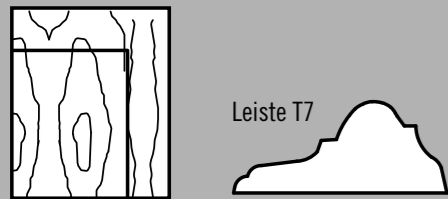

AACHEN auf Rahmen furniert

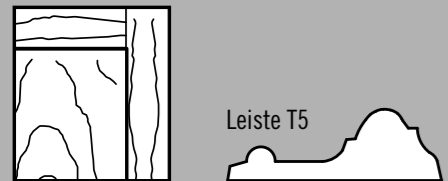

AUFSATZLEISTEN

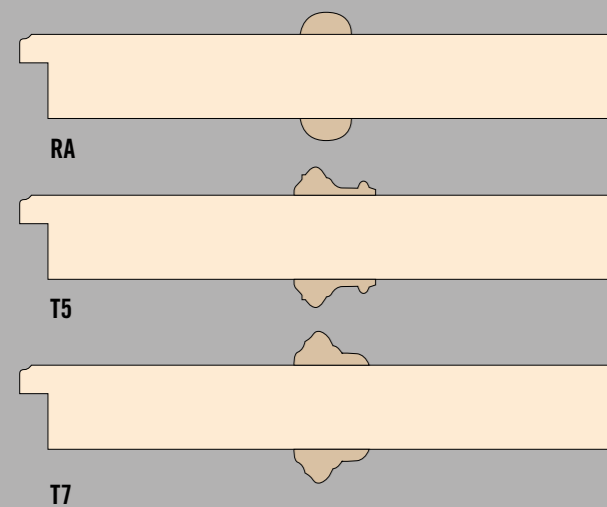

SAARBRÜCKEN durchlaufend furniert



Oberfläche: Buche
Modell: Saarbrücken G21 (T7)
Zarge: Bebo



Oberfläche: Canadisch Ahorn
Modell: Aachen S01 (T5)
Zarge: Soft

AACHEN auf Rahmen furniert

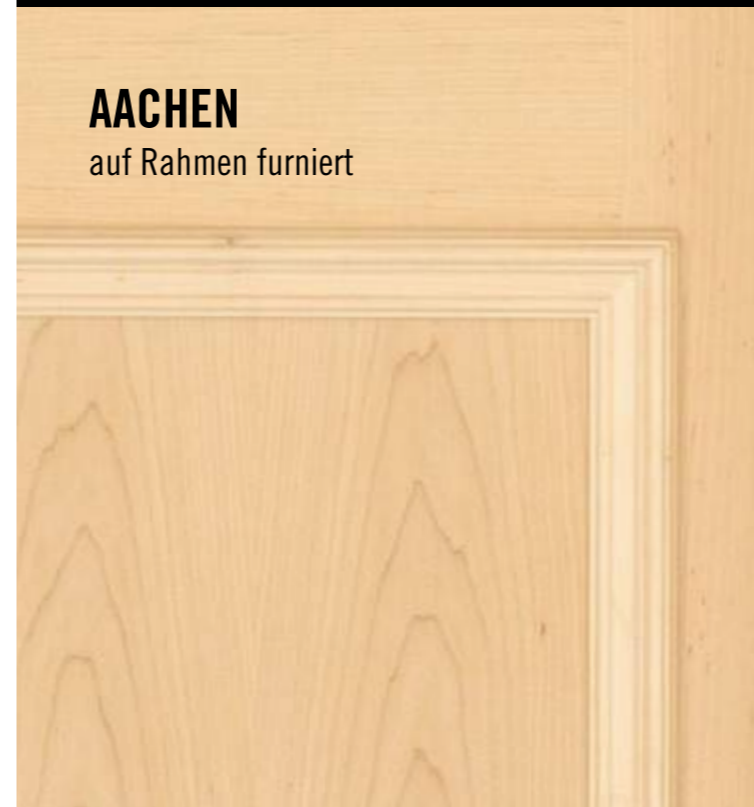

MODELLVARIATIONEN

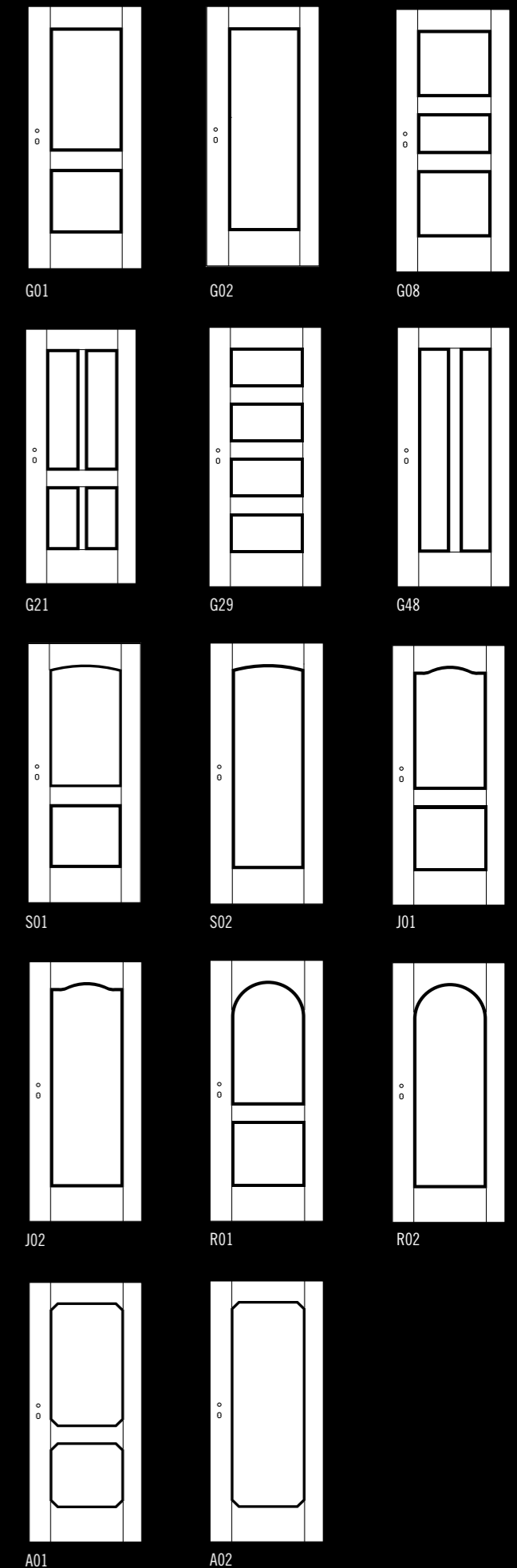

STILTÜREN ECHTE FÜLLUNGSTÜREN

- Mittellage: Vollspankern oder Stäbchenmittellage
- 5 cm kürzbar
- massiver Fichte / Tanne Rahmen
- Franken Füllung mit Leiste Form E Standard
- alternative Füllungen und Leistenformen möglich

FRANKEN

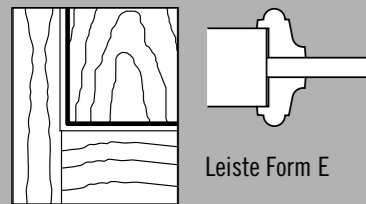

Leiste Form E

BADEN / ALBUCH

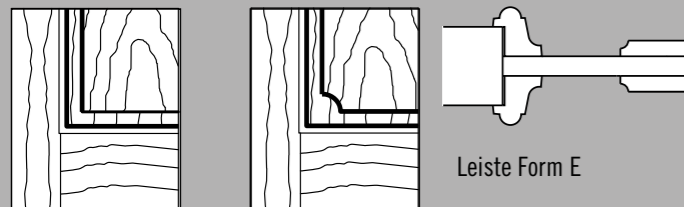

Baden

Albuch

Leiste Form E

CHIEMSEE

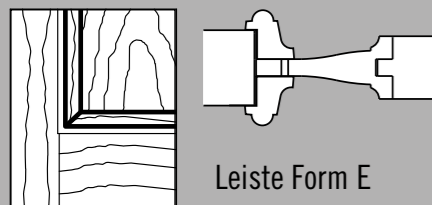

Leiste Form E



Oberfläche: Eiche
Modell: Franken S01 (Leiste Form E)
Zarge: Soft

BADEN / ALBUCH



Oberfläche: Canadisch Ahorn
Modell: Baden B02 Soft
Zarge: Soft mit Leiste TG



Oberfläche: Eiche
Modell: Chiemsee G01 (Leiste RG)
Zarge: Bebo

FRANKEN



CHIEMSEE





Oberfläche: Eiche Astig
Modell: Albuch G03
Glas: Bio 06
Zarge: Soft



Oberfläche: Eiche Weiss Mattlack
Modell: Baden RJ19
Glas: Satinato Stern
Zarge: Soft

MODELLVARIATIONEN

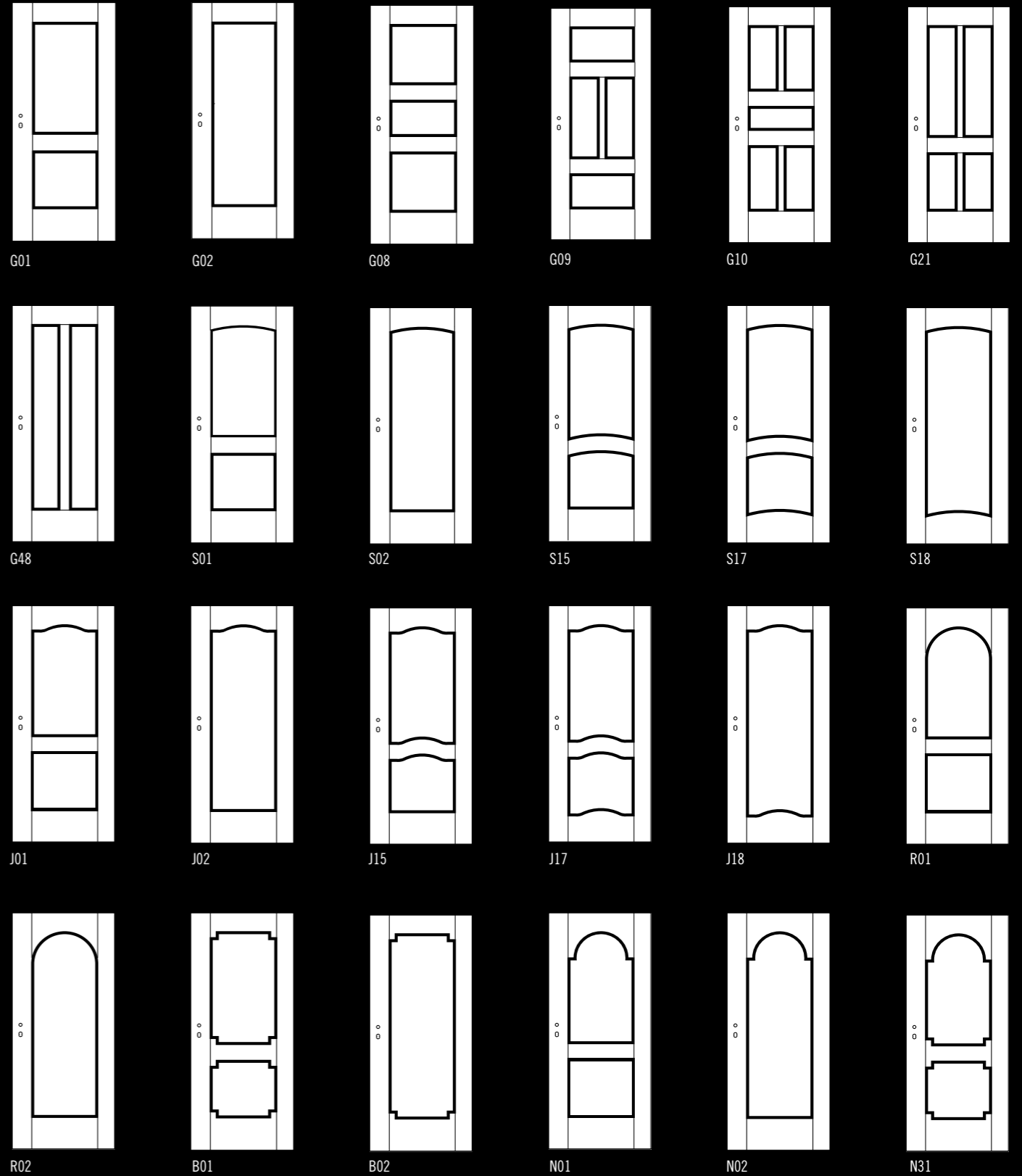

WEITERE LEISTENFORMEN



LANDHAUSTÜREN

- Friestüre mit tiefliegender Füllung
- je nach Modell inkl. 8 mm Float ESG- Glas und / oder Holzfüllung
- alternative Gläser möglich
- MDF Fries ummantelt
- 5 cm kürzbar

FRANKEN

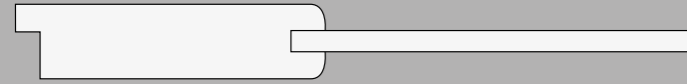

BADEN

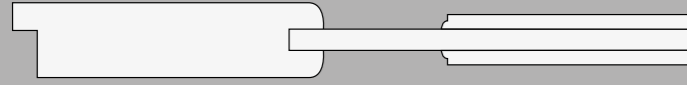

CHIEMSEE

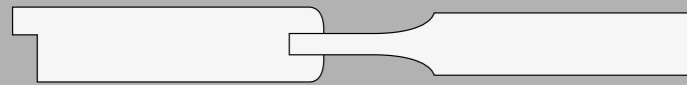

QUERSCHNITTE

Eckig



Soft



Soft 2

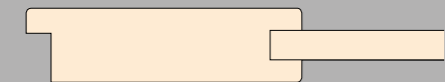

Oberfläche: Eiche
Modell: ALG 29 Füllung Franken
Zarge: Soft



Oberfläche: Eiche Astig
Modell: ALG 48 Füllung Franken
Zarge: Soft



Oberfläche: Eiche Astig Weiss mattlack
Modell: ALG01 Füllung Franken
Zarge: Bebo





Holzart: Boire
 Modell: ALG26 Füllung Franken
 Glas: Rose negativ Satinato
 Zarge: Bebo



Holzart: RAL Weiss
 Modell: ALG22 Füllung Franken
 Glas: Pave Weiss
 Zarge: Bebo

MODELLVARIATIONEN

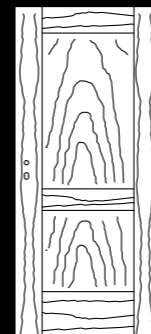

ALG 01



ALG 02

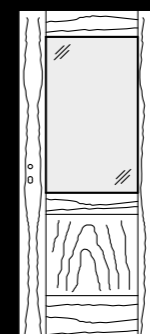

ALG 03

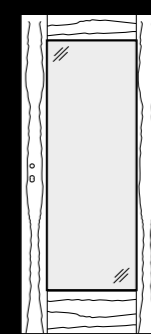

ALG 04

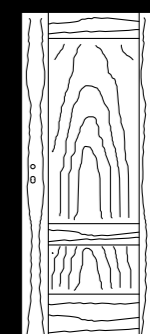

ALG 16

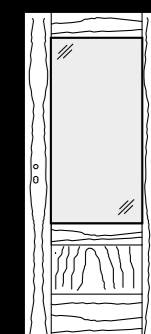

ALG 17

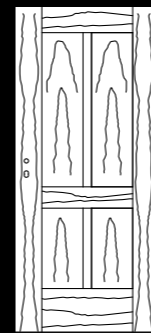

ALG 21

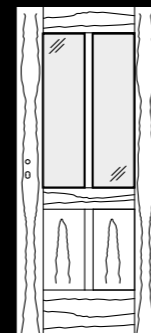

ALG 22

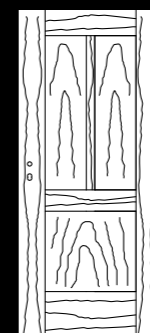

ALG 25

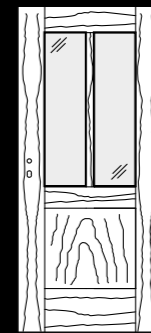

ALG 26

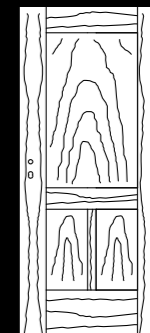

ALG 27

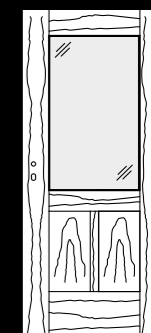

ALG 28

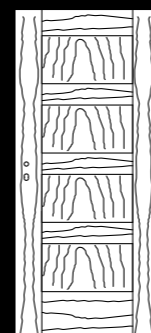

ALG 29

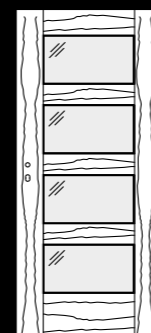

ALG 30

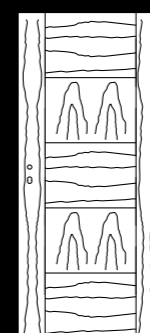

ALG 32

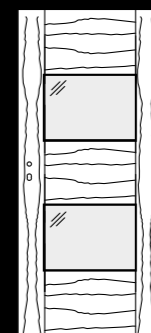

ALG 33

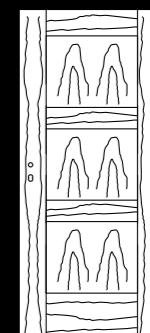

ALG 34

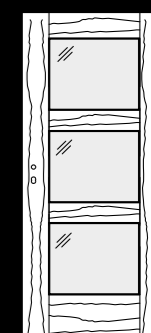

ALG 35

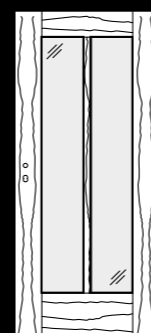

ALG 47

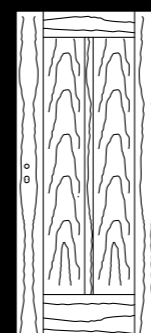

ALG 48

HPL TÜREN

- Mittellage: Röhrenspankern, Vollspan oder Stäbcheneinlage
- dreiseitiger Buche - Einleimer klar lackiert
Alternativ: Kanten farblich passend lackiert
- 5 cm kürzbar



- Bei all unseren HPL Türen werden standardmäßig hochwertige Buche Einleimer verbaut.
- HPL-Zargen / Blockrahmen / Windfang usw. können ebenfalls auf Anfrage gefertigt werden.
- HPL standardmäßig von Egger und Resopal. Alternative Hersteller auf Anfrage möglich



Oberfläche: HPL - Weiss
Modell: G00
Zarge: Eckig



Oberfläche: Resopal Eiche Astig
Modell: Naomi 01
Zarge: Eckig



Oberfläche: HPL - Global Metall
Modell: G00
Zarge: Eckig

SCHIEBETÜREN

Laufschiene Stop - Close in folgenden Varianten erhältlich

- mit einseitiger Blende in Edelstahloptik passend für Wandmontage
- mit beidseitiger Blende in Edelstahloptik passend für Deckenmontage
- passend für deckenbündigen Einbau
- passend für alle Konold-Schiebetürzargen
- Alternativ Soft Close - Funktion nur einseitig, dafür einseitig mit Tip-On-Funktion (nach leichtem Druck auf die Kante springt die Türe einige Zentimeter aus der Wandtasche)

Einfacher Ein- und Ausbau dank Revisionsklammer

LAUFSCHIENEN

Wandmontage Holzschiebetüre
Vor der Wand



Blende:
Erhältlich in Edelstahloptik.

LAUFSCHIENEN

Wandmontage Glasschiebetüre
Vor der Wand

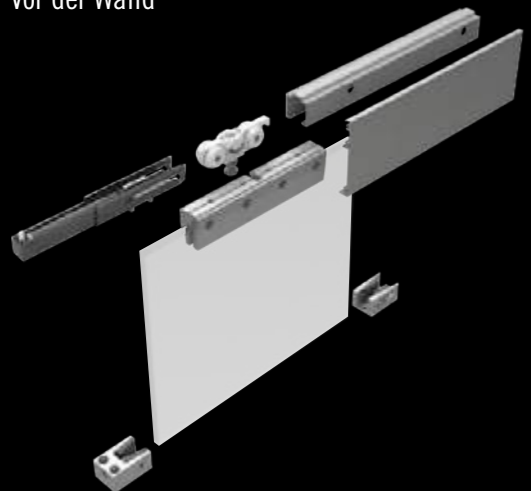

Ganzglastüre Satinato mit Swarovski Elements vor der Wand laufend mit Griffmuschel MU4.



Ganzglastüre Q50 Satinato in der Wand laufend. Einfacher Ein- und Ausbau dank Revisionsklammern. Mit Griffstange KOGR 30.



G00 Palisander vor der Wand laufend. Laufschiene flächenbündig mit der Decke verputzt. Flansch für Niedereinbau in die Türe eingearbeitet. Griffmuschel GM15.

FURNIERAUSWAHL



KOHO SCHNELLSTIFT GARNITUREN

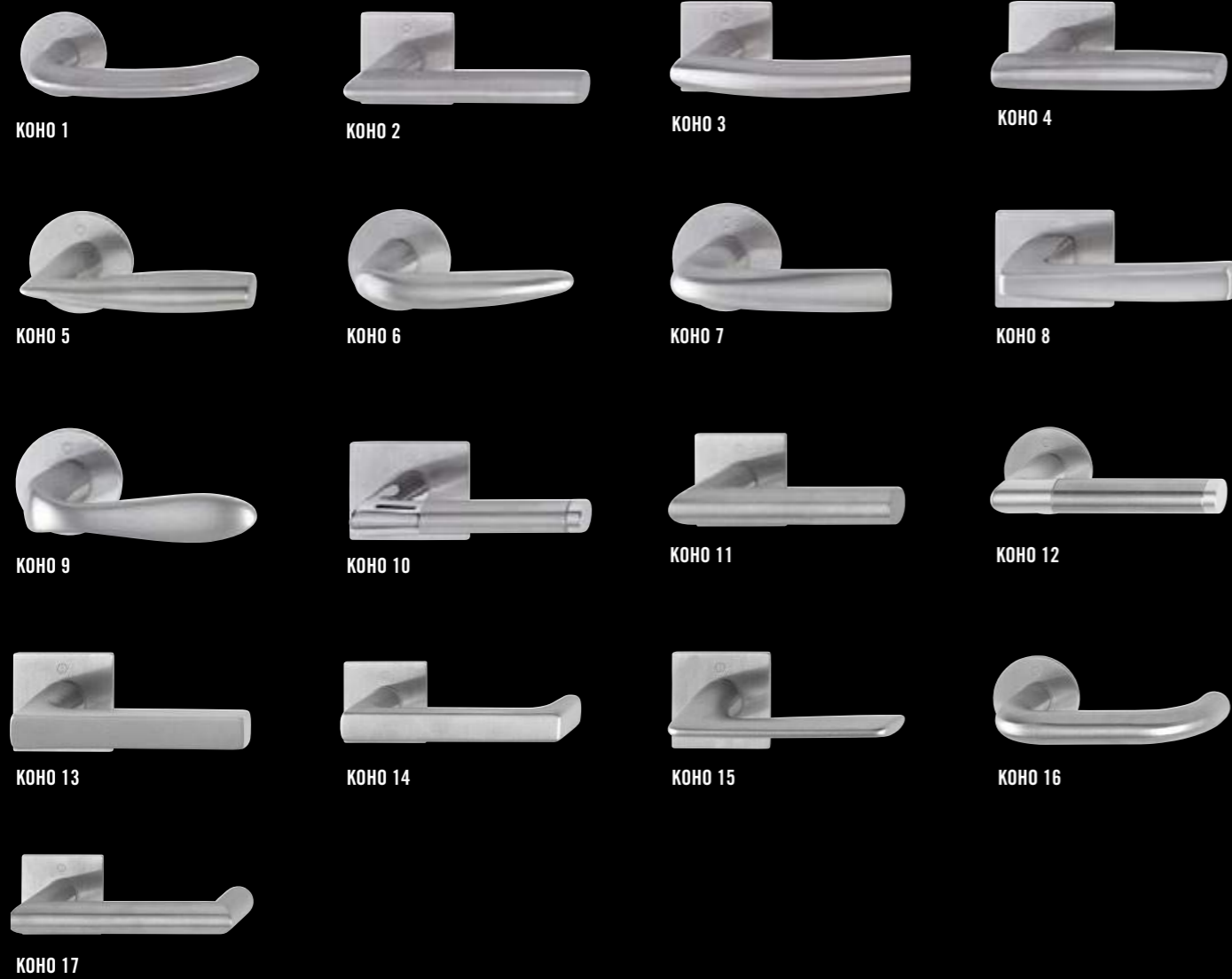

BESCHLÄGE GLASTÜREN

GRIFSTANGE KOGU

Während die meisten Schiebetüren, ob Glas oder Holz nur bis zur Position der Griffe zu öffnen sind, bietet KONOLD eine wirklich intelligente Lösung. Die Griffstange KOGU ist auf der Rückseite mit einer Griffmuschel versehen. Die Glasschiebetüren können somit vollständig vor die Wand geschoben werden. Die Griffstange KOGU ist auf Wunsch in verschiedenen Längen und Durchmessern erhältlich.

GRIFSTANGEN KOGR

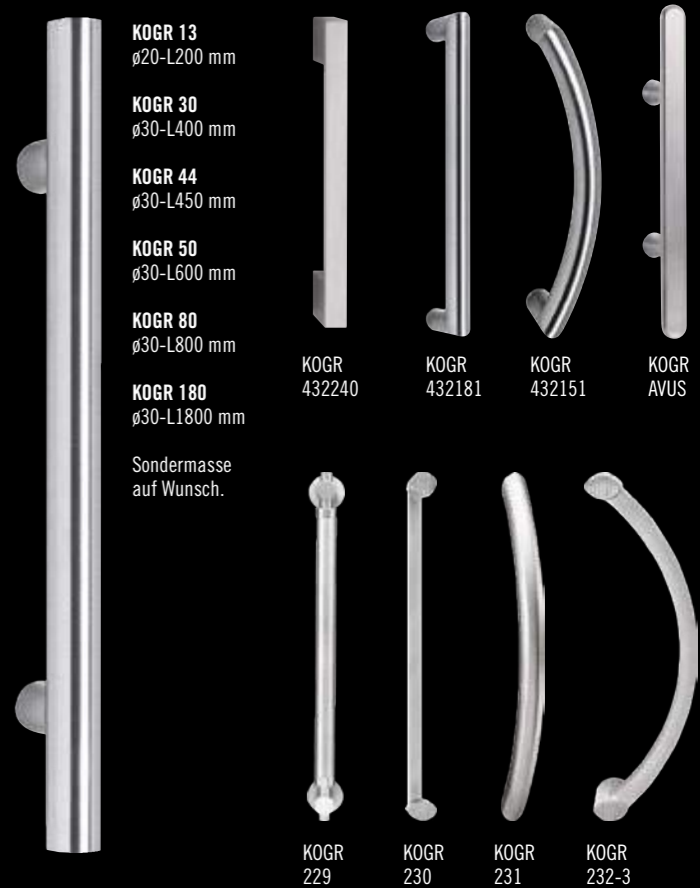

KOHO SCHLÜSSEL ROSETTEN

Frei kombinierbar!
Rosetten können untereinander getauscht werden.



GANZGLAS DRÜCKER KOGL

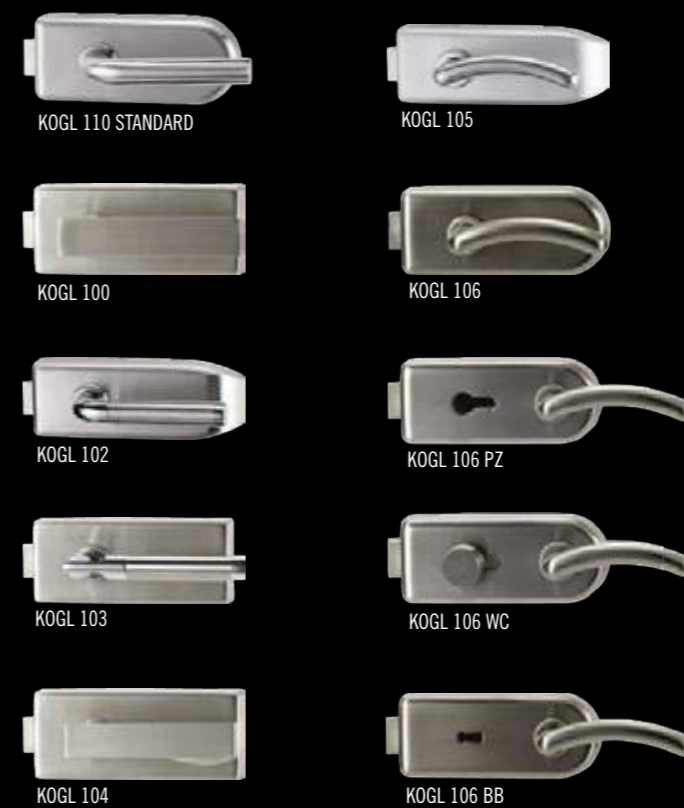

GRIFMUSCHELN GLAS



GRIFMUSCHELN HOLZ



BODENDICHTUNGSAUTOMAT

Bodendichtungsautomat für Holz-, Konglas und Ganzglastüren erhältlich.



GA1 - Lippendichtung zum Nachrüsten

GA2 - Standard

BEKLEIDUNGSFORMEN GEFÄLTZT

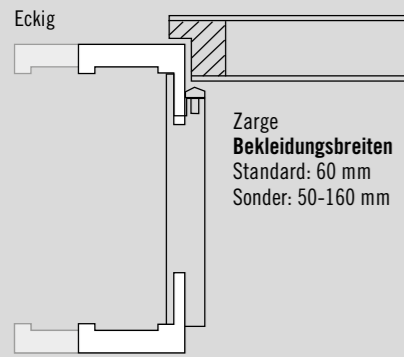

Eckig

Zarge
Bekleidungsbreiten
Standard: 60 mm
Sonder: 50-160 mm

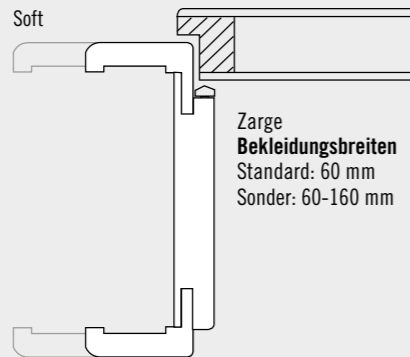

Soft

Zarge
Bekleidungsbreiten
Standard: 60 mm
Sonder: 60-160 mm

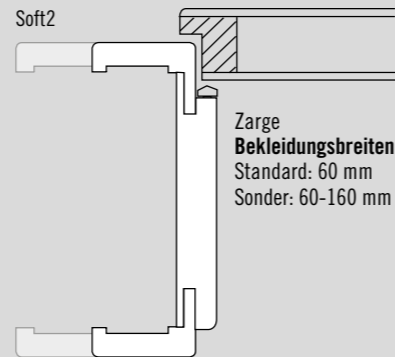

Soft2

Zarge
Bekleidungsbreiten
Standard: 60 mm
Sonder: 60-160 mm



BEFA

Zarge
Bekleidungsbreiten
Standard: 60 mm
Sonder: 60-160 mm

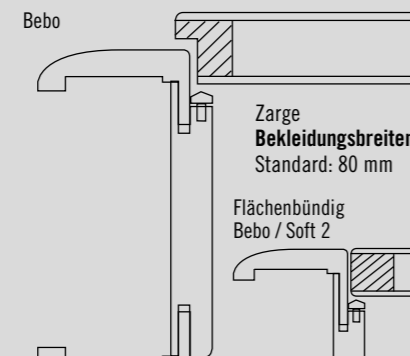

Bebo

Zarge
Bekleidungsbreiten
Standard: 80 mm

Flächenbündig
Bebo / Soft 2

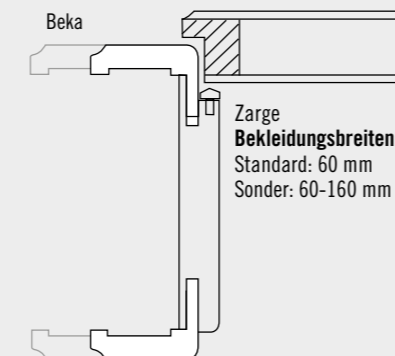

Beka

Zarge
Bekleidungsbreiten
Standard: 60 mm
Sonder: 60-160 mm

FURNIERART UND FURNIERRICHTUNG

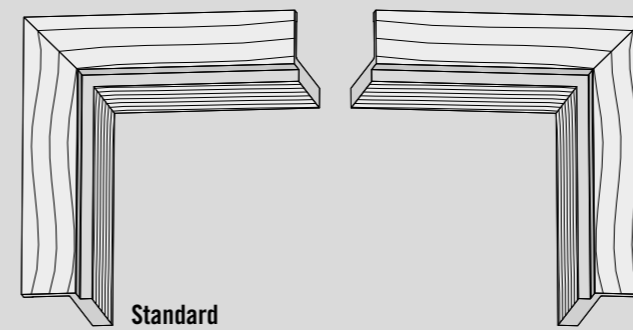

Standard

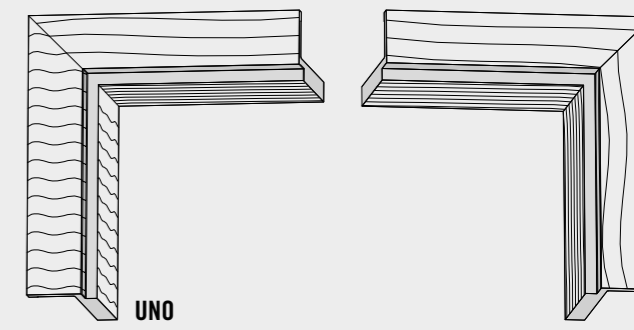

UNO

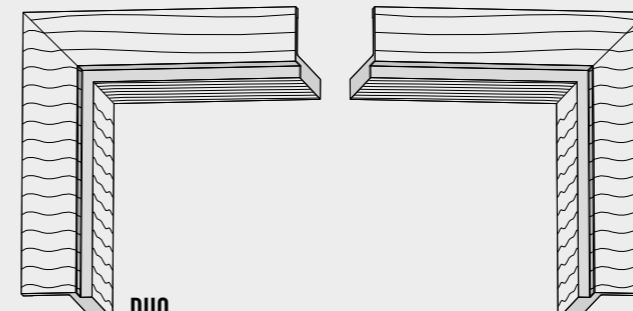

DUO

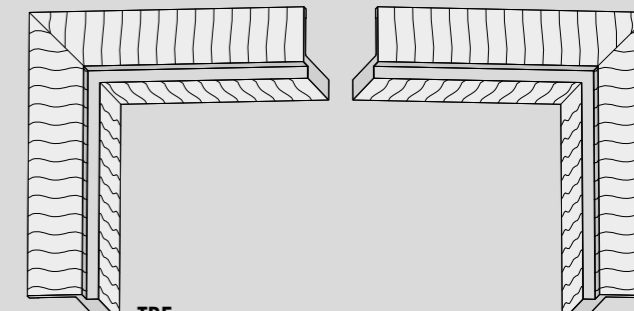

TRE

BEKLEIDUNGSFORMEN STUMPF

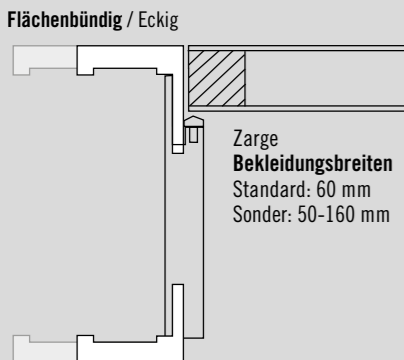

Flächenbündig / Eckig

Zarge
Bekleidungsbreiten
Standard: 60 mm
Sonder: 50-160 mm

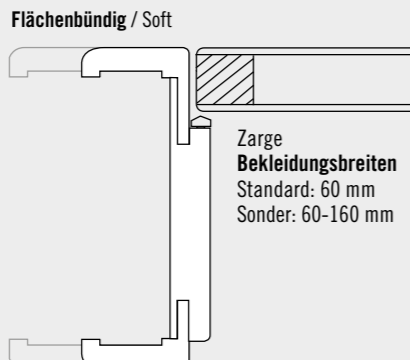

Flächenbündig / Soft

Zarge
Bekleidungsbreiten
Standard: 60 mm
Sonder: 60-160 mm



Flächenbündig / Soft2

Zarge
Bekleidungsbreiten
Standard: 60 mm
Sonder: 60-160 mm

AUSFÜHRUNGEN

Zargen (gefälzt)

- Umfassungszarge mit 3-seitigem Dämpfungsprofil
- Futterbrett: ca. 22 mm stark
- Bekleidungen: 60 mm breit, 16 mm stark
- Falz 12 x 30,5 mm passend für Normtürblatt
- Wandstärken 60 - 75 mm NICHT verstellbar
- Verstellbereich ab Wandstärke 80 mm -5 mm / +10 mm

Mögliche Ausführungen:

- Bekleidungsformen: Kantig, Soft, Soft2, Bebo, Befa, Beso, Beka
- rückwärtige Spiegelverlängerung zur Wand bis 23 mm möglich!
- Bekleidungsbreiten: 50 mm - 140 mm möglich!
- Wandstärken bis 700 mm lieferbar

Türen (gefälzt)

- Türblatt ca. 41 mm stark
- mit Falz 13 x 25,5 mm
- unten ca. 50 mm kürzbar
- massiver Fichte / Tanne Rahmen

Mögliche Ausführungen:

- Kantenform: Kantig, Soft, Soft2, Karnies
- Mittellagen: Röhrenspankern, Vollspankern, Spezialverbundplatte, Stäbchenmittellage

Zargen (stumpf)

- Umfassungszarge mit 3-seitigem Dämpfungsprofil
- Futterbrett: ca. 22 mm stark
- Bekleidungen: 60 mm breit, 16 mm stark
- Falz 12 x 46 mm passend für stumpfes Türblatt
- Verstellbereich ab Wandstärke 100 mm -5 mm / +10 mm
- Ankerplatte für verdeckt liegendes 3-D-Band
- Magnetschließblech Edelstahl
- lose, kartonverpackt

Mögliche Ausführungen:

- Bekleidungsformen: Kantig, Soft, Soft2, Bebo, Befa, Beso, Beka
- rückwärtige Spiegelverlängerung zur Wand bis 23 mm möglich!
- Bekleidungsbreiten: 50 mm - 140 mm möglich!
- Wandstärken bis 700 mm lieferbar

Türen (stumpf)

- Türblatt ca. 41 mm stark
- unten ca. 50 mm kürzbar
- verdeckt liegendes 3-D-Band TE 340
- Magnetschloss Edelstahl
- massiver Fichte / Tanne Rahmen

Mögliche Ausführungen:

- Kantenform: Kantig, Soft2
- Mittellagen: Röhrenspankern, Vollspankern, Spezialverbundplatte, Stäbchenmittellage